

- LEGEND:**
- REVISED SITE BOUNDARY
 - - - FOLIO NOT INCLUDED IN THE SITE BOUNDARY
 - DEVELOPMENT PERMITTED UNDER AN BORD PLEANÁLA REFERENCE ABP-313750-22
 - PERMITTED 110kV UNDERGROUND CABLING TO BE OMITTED
 - PERMITTED SECTION OF WIND FARM CABLING TO BE REVISED
 - PROPOSED ACCESS TRACKS
 - - - PROPOSED REVISED ROUTE OF WIND FARM CABLING
 - - - PROPOSED WIND FARM CABLING

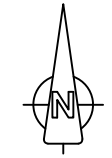

OSI © Licence: CYAL50441216 - OS Map Ref. No. - Prepared Using Irish Transverse Mercator (ITM).

Date:	Rev:	Description:	Drawn By:

Prepared By:

Galetech Energy Services
 Clondargan, Stradone
 Co. Cavan, H12 NV06
 info@galetechenergyservices.com
 www.galetechenergyservices.com

Client: ENERGIA RENEWABLES ROI LTD.

Job Title: SEVEN HILLS WIND FARM - SECTION 146B REQUEST

Drawing Title:

FIGURE 1.0: OVERALL SITE LOCATION

Drawing No.: SEV001S146B_PAS_LOC-0.01	Stage: PLANNING
Scale: (A3) 1:100,000	Date: 11/12/2025
Drawn By: EF	Checked By: JB
Revision No.: REV 04	Confirmed By: SC

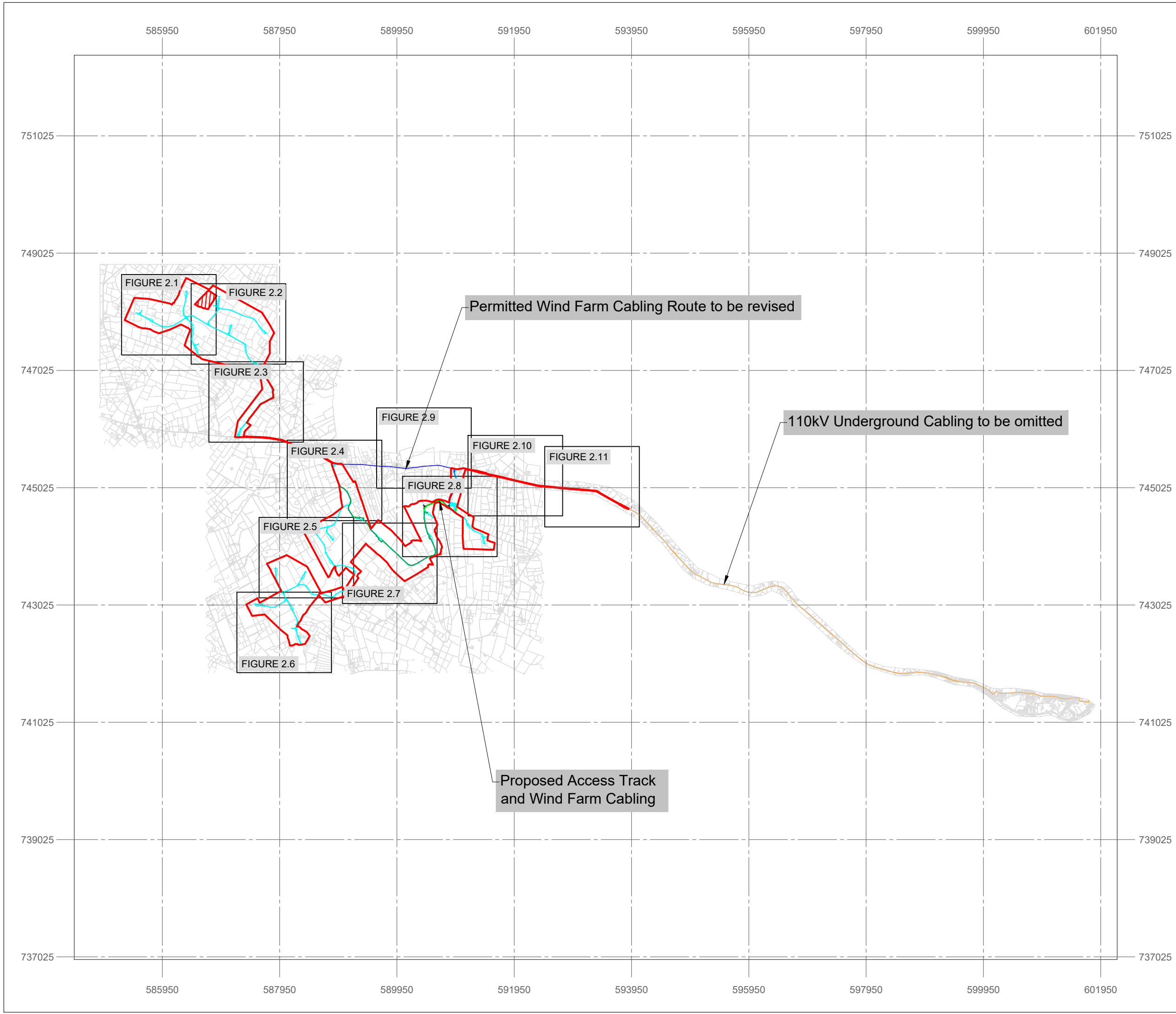

LEGEND:

- REVISIED SITE BOUNDARY
- FOLIO NOT INCLUDED IN THE SITE BOUNDARY
- DEVELOPMENT PERMITTED UNDER AN BORD PLEANÁLA REFERENCE ABP-313750-22
- PERMITTED 110kV UNDERGROUND CABLING TO BE OMITTED
- PERMITTED SECTION OF WIND FARM CABLING TO BE REVISED
- PROPOSED ACCESS TRACKS
- PROPOSED REVISED ROUTE OF WIND FARM CABLING
- PROPOSED WIND FARM CABLING

N

OSI © Licence: CYAL50441216 - OS Map Ref. No. - Prepared Using Irish Transverse Mercator (ITM).

Date:	Rev:	Description:	Drawn By:
Prepared By:			



 Galetech Energy Services
 Clondargan, Stradone
 Co. Cavan, H12 NV06
 info@galetechenergyservices.com
 www.galetechenergyservices.com

Client: ENERGIA RENEWABLES ROI LTD.

Job Title: SEVEN HILLS WIND FARM - SECTION 146B REQUEST

Drawing Title: FIGURE 2.0: SITE LOCATION MAPS DRAWING KEY

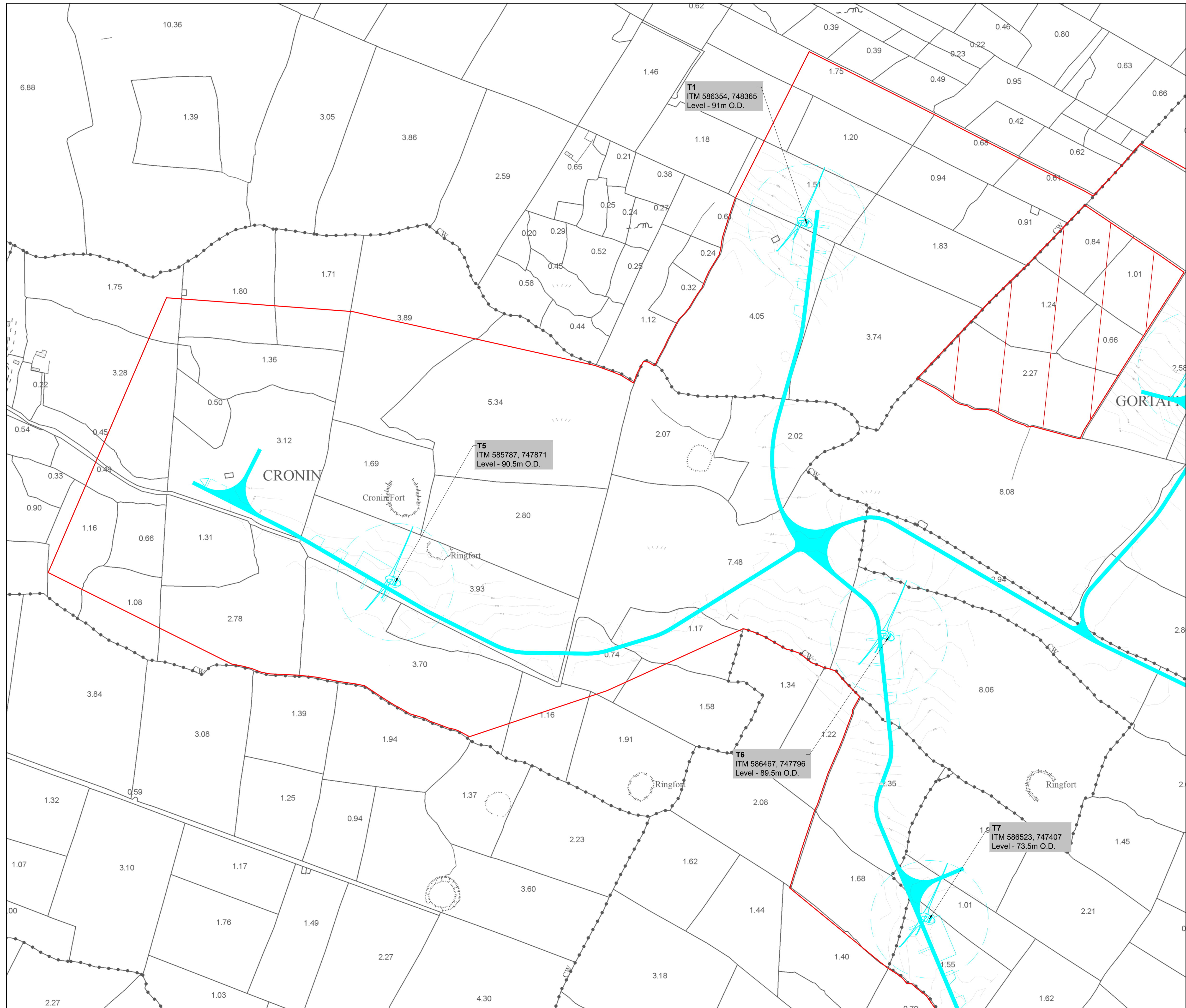
Drawing No.: SEV001S146B_PAS_LOC-0.02	Stage: PLANNING	
Scale: (A3) 1:100,000	Date: 11/12/2025	Revision No.: REV 04
Drawn By: EF	Checked By: JB	Confirmed By: SC



LEGEND:

- ▬ REVISED SITE BOUNDARY
- ▨ FOLIO NOT INCLUDED IN THE SITE BOUNDARY
- ▬ DEVELOPMENT PERMITTED UNDER AN BORD PLEANÁLA REFERENCE ABP-313/50-22
- ▬ PERMITTED 110KV UNDERGROUND CABLING TO BE OMITTED
- ▬ PERMITTED SECTION OF WIND FARM CABLING TO BE REVISED
- ▬ PROPOSED ACCESS TRACKS
- ▬ PROPOSED REVISED ROUTE OF WIND FARM CABLING
- ▬ PROPOSED WIND FARM CABLING
- ▬ CONTOUR LINES

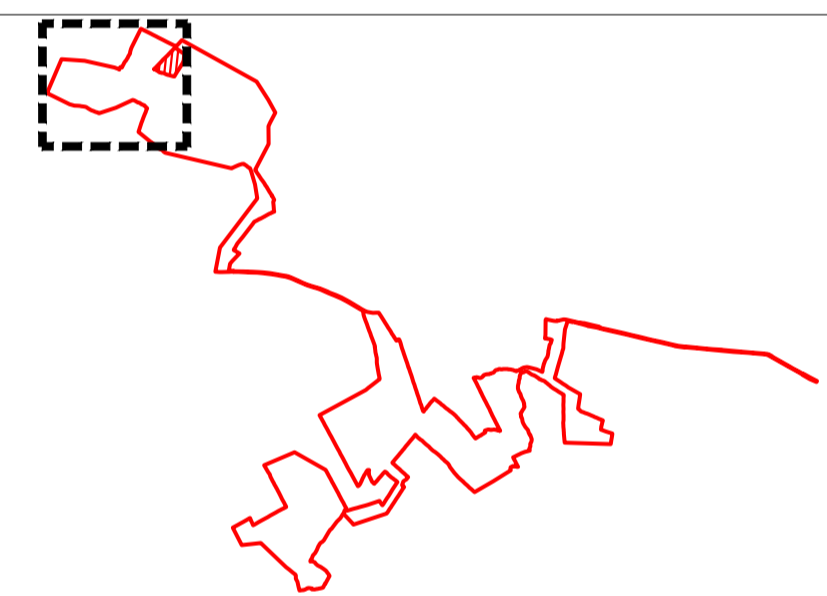
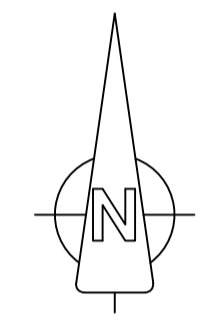

OSI © Licence: CYAL50441216 - OS Map Ref. No. - Prepared Using Irish Transverse Mercator (ITM).

Date:	Rev:	Description:	Drawn By:

Prepared By:

Galetech Energy Services
Clondargan, Stradone
Co. Cavan, H12 NV06
info@galetechenergyservices.com
www.galetechenergyservices.com

Client: **ENERGIA RENEWABLES ROI LTD.**

Job Title: **SEVEN HILLS WIND FARM - SECTION 146B REQUEST**

Drawing Title: **FIGURE 2.1: SITE LOCATION MAP 1 OF 11**

Drawing No. SEV001S146B_PAS_LOC-0.03	Stage. PLANNING
---	--------------------

Scale: (A1) 1:2,500	Date: 11/12/2025	Revision No.: REV 04
------------------------	---------------------	-------------------------

Drawn By: EF	Checked By: JB	Confirmed By: SC
-----------------	-------------------	---------------------

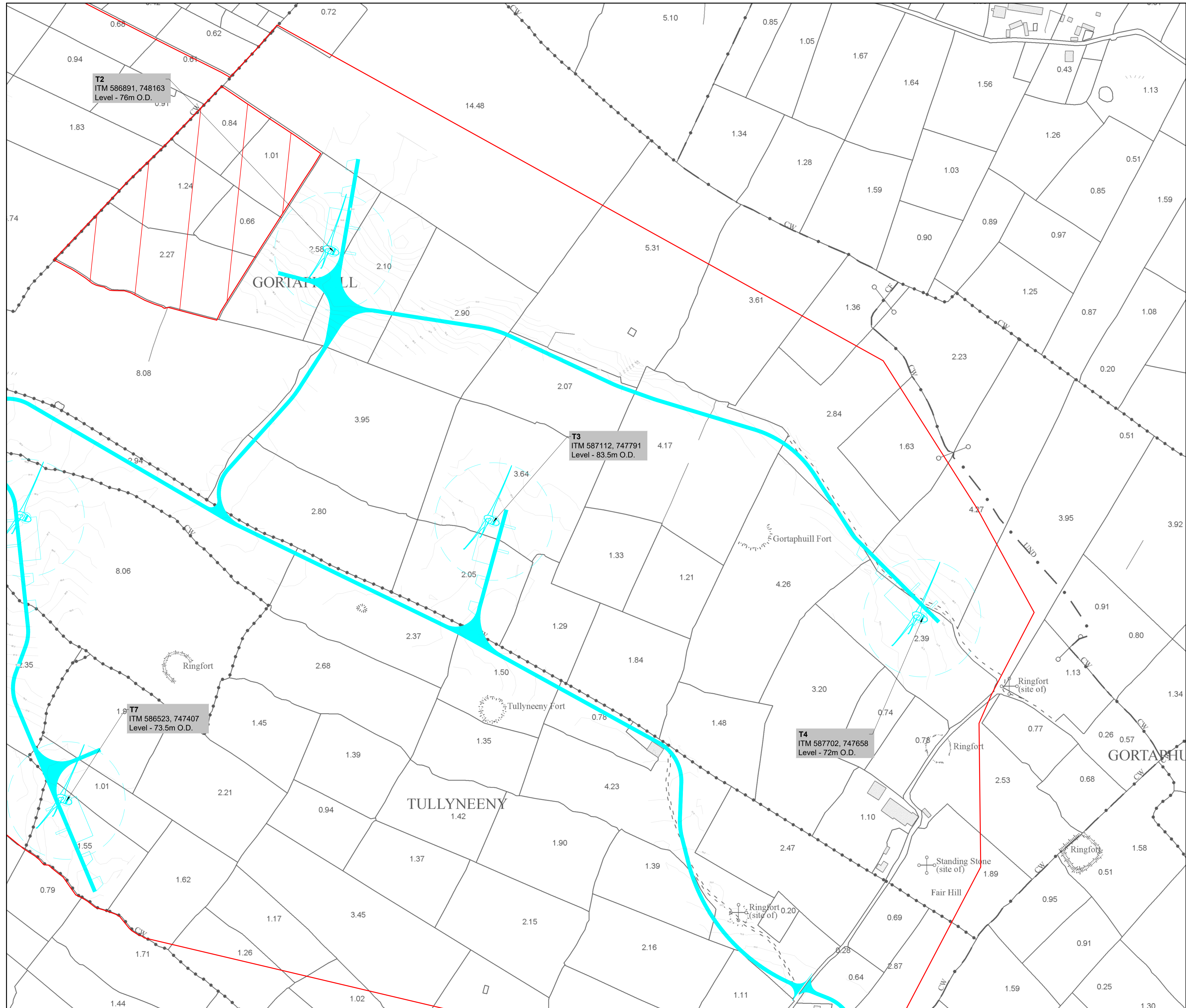

- LEGEND:**
- REVISED SITE BOUNDARY
 - FOLIO NOT INCLUDED IN THE SITE BOUNDARY
 - DEVELOPMENT PERMITTED UNDER AN BORD PLEANÁLA REFERENCE ABP-313/50-22
 - PERMITTED 110KV UNDERGROUND CABLING TO BE OMITTED
 - PERMITTED SECTION OF WIND FARM CABLING TO BE REVISED
 - PROPOSED ACCESS TRACKS
 - PROPOSED REVISED ROUTE OF WIND FARM CABLING
 - PROPOSED WIND FARM CABLING
 - CONTOUR LINES

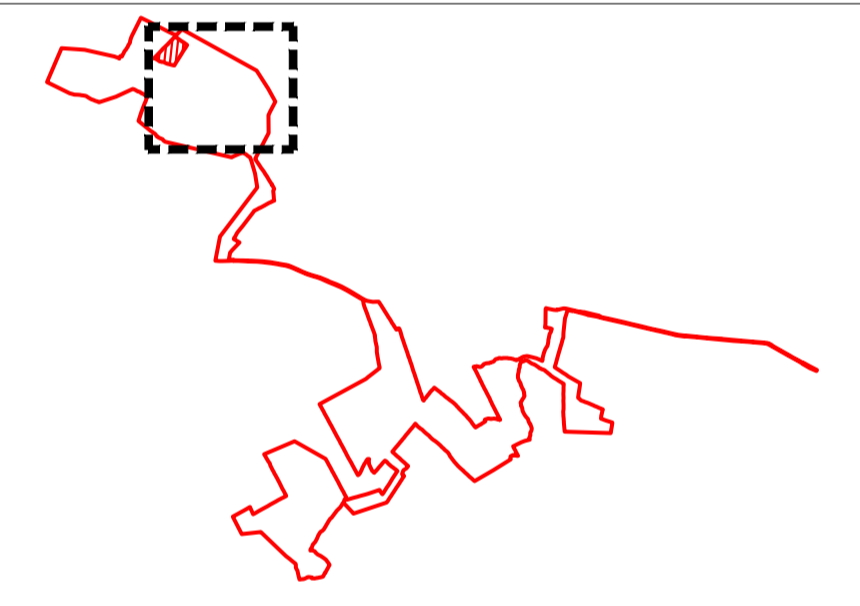
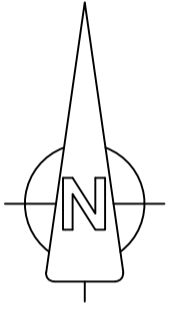

OSI © Licence: CYAL50441216 - OS Map Ref. No. - Prepared Using Irish Transverse Mercator (ITM).

Date:	Rev:	Description:	Drawn By:

Prepared By:

Gaitech Energy Services
 Clondargan, Stradone
 Co. Cavan, H12 NV06
 info@gatechenergyservices.com
 www.gatechenergyservices.com

Client: ENERGIJA RENEWABLES ROI LTD.

Job Title: SEVEN HILLS WIND FARM - SECTION 146B REQUEST

Drawing Title: FIGURE 2.2: SITE LOCATION MAP 2 OF 11

Drawing No. SEV001S146B_PAS_LOC-0.04	Stage: PLANNING
--	---------------------------

Scale: (A1) 1:2,500	Date: 11/12/2025	Revision No.: REV 04
-------------------------------	----------------------------	--------------------------------

Drawn By: EF	Checked By: JB	Confirmed By: SC
------------------------	--------------------------	----------------------------

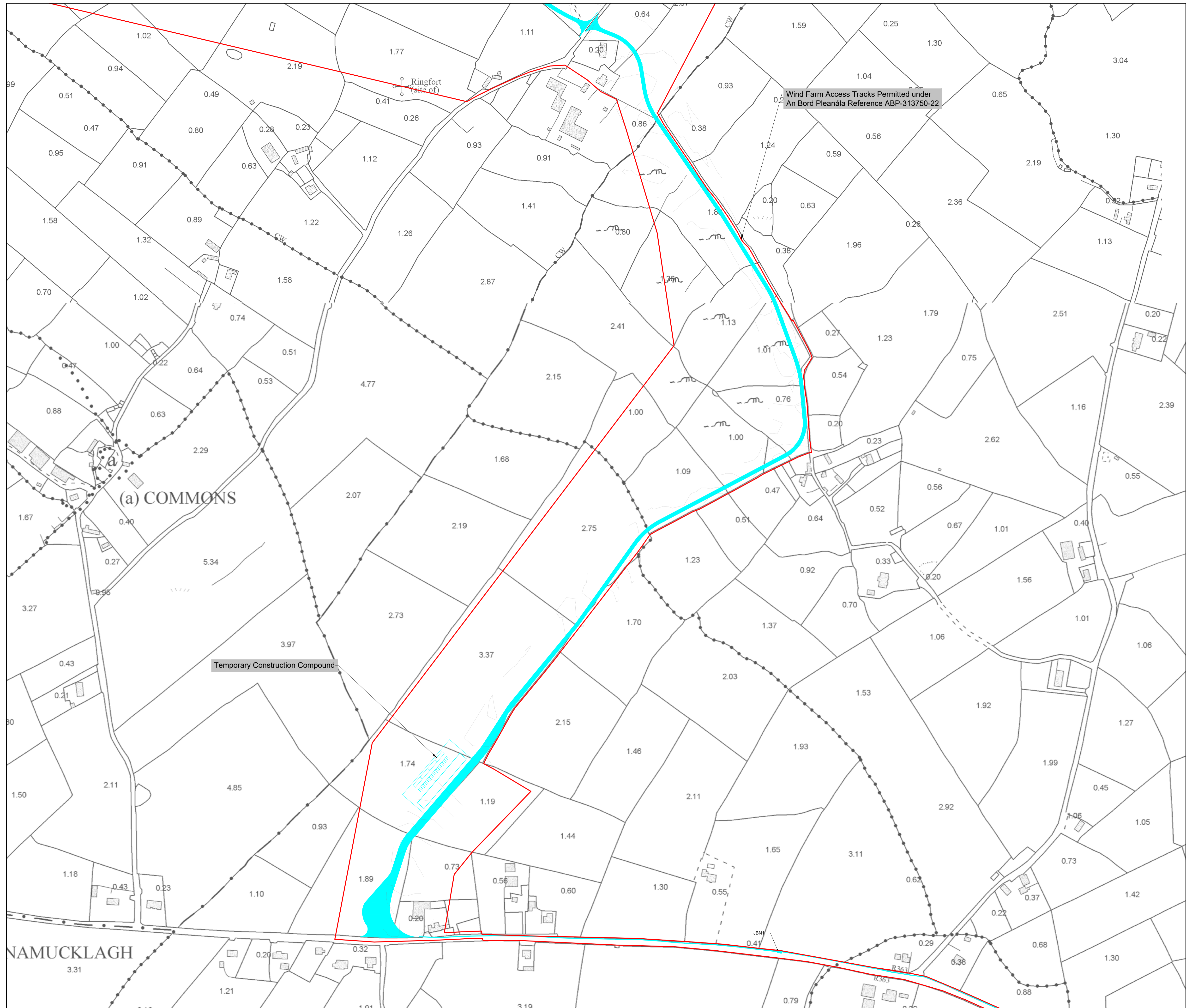

- LEGEND:**
- ▬▬▬ REVISED SITE BOUNDARY
 - ▬▬▬ FOLIO NOT INCLUDED IN THE SITE BOUNDARY
 - ▬▬▬ DEVELOPMENT PERMITTED UNDER AN BORD PLEANÁLA REFERENCE ABP-313750-22
 - ▬▬▬ PERMITTED 110KV UNDERGROUND CABLING TO BE OMITTED
 - ▬▬▬ PERMITTED SECTION OF WIND FARM CABLING TO BE REVISED
 - ▬▬▬ PROPOSED ACCESS TRACKS
 - - - PROPOSED REVISED ROUTE OF WIND FARM CABLING
 - - - PROPOSED WIND FARM CABLING
 - ▬▬▬ CONTOUR LINES

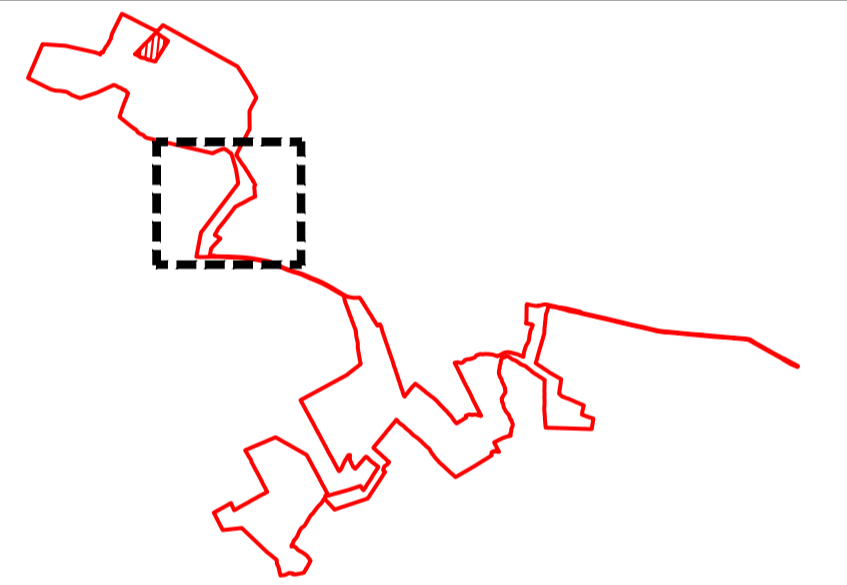
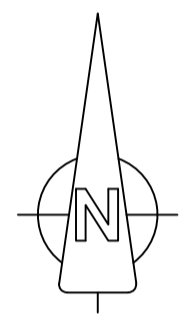

OSI © Licence: CYAL50441216 - OS Map Ref. No. - Prepared Using Irish Transverse Mercator (ITM).

Date:	Rev:	Description:	Drawn By:

Prepared By:



Galetech Energy Services
Clondargan, Stradone
Co. Cavan, H12 NV06
info@galetechenergyservices.com
www.galetechenergyservices.com

Client:	ENERGIA RENEWABLES ROI LTD.
Job Title:	SEVEN HILLS WIND FARM - SECTION 146B REQUEST
Drawing Title:	FIGURE 2.3: SITE LOCATION MAP 3 OF 11
Drawing No.:	SEV001S146B_PAS_LOC-005
Stage:	PLANNING

Scale:	Date:	Revision No.:
(A1) 1:2,500	11/12/2025	REV 04
Drawn By:	Checked By:	Confirmed By:
EF	JB	SC

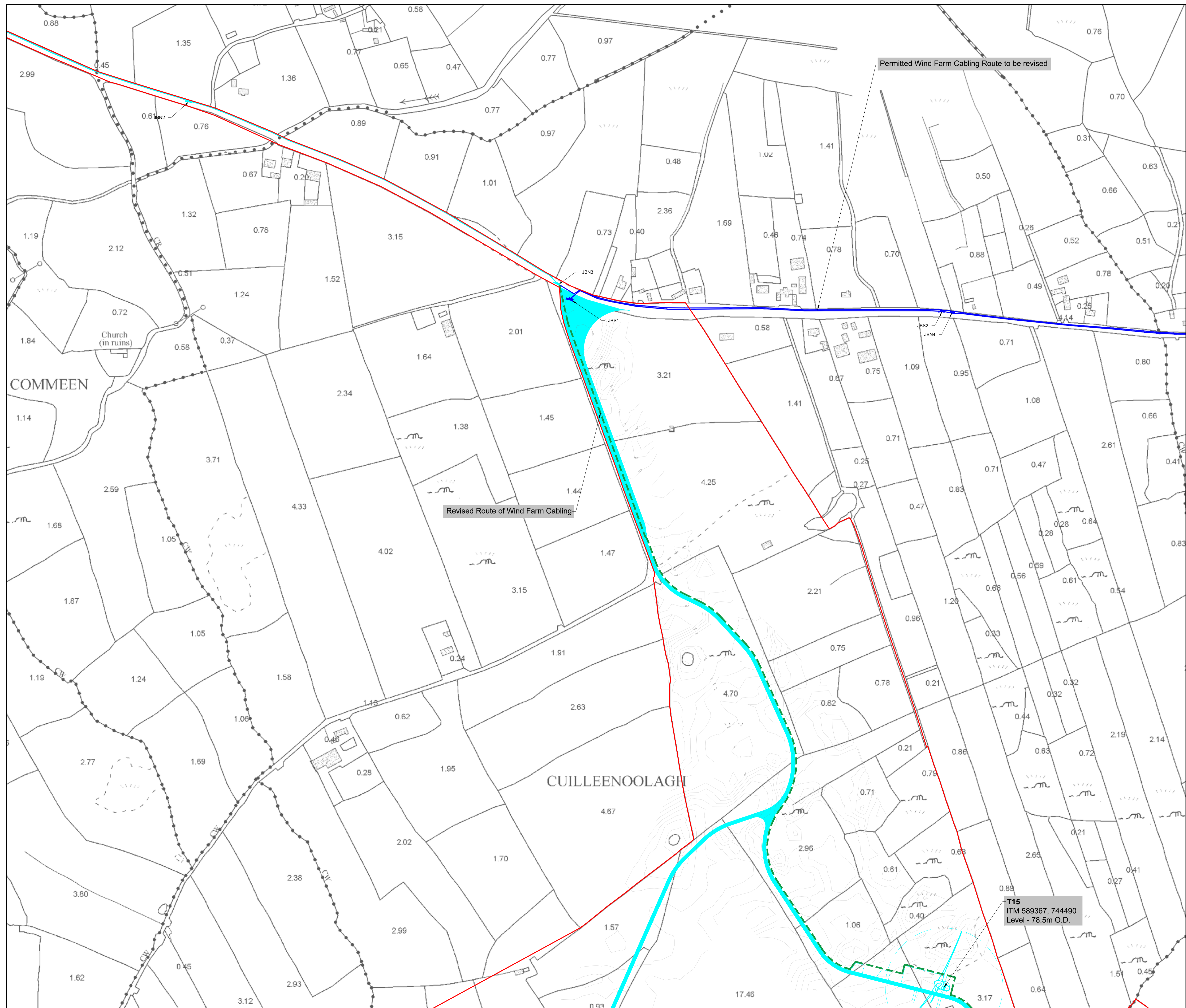

- LEGEND:**
- REVISED SITE BOUNDARY
 - FOLIO NOT INCLUDED IN THE SITE BOUNDARY
 - DEVELOPMENT PERMITTED UNDER AN BORD PLEANALA REFERENCE ABP-313750-22
 - PERMITTED 110KV UNDERGROUND CABLING TO BE OMITTED
 - PERMITTED SECTION OF WIND FARM CABLING TO BE REVISED
 - PROPOSED ACCESS TRACKS
 - PROPOSED REVISED ROUTE OF WIND FARM CABLING
 - PROPOSED WIND FARM CABLING
 - CONTOUR LINES

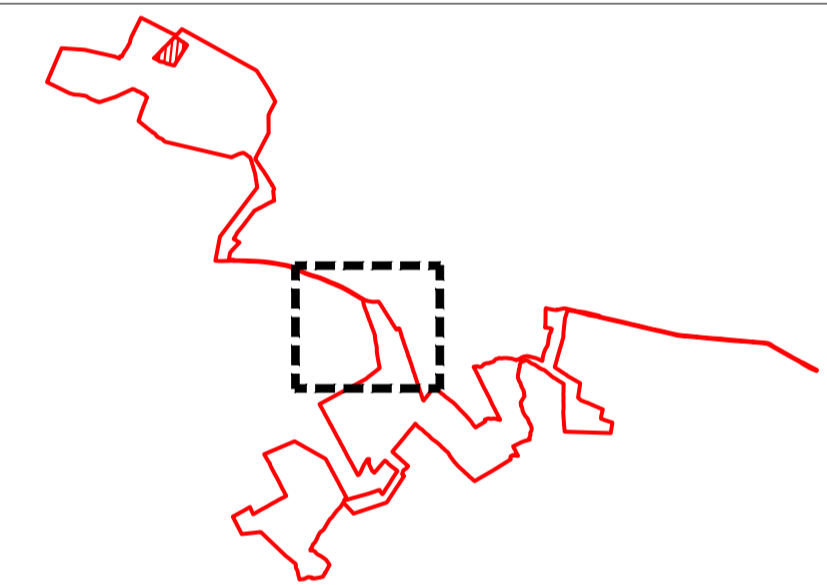
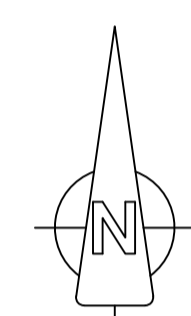

OSI © Licence: CYAL50441216 - OS Map Ref. No. - Prepared Using Irish Transverse Mercator (ITM).

Date:	Rev:	Description:	Drawn By:
Prepared By:			

Gaitech Energy Services
 Clondargan, Stradone
 Co. Cavan, H12 NV06
 info@gatechenergyservices.com
 www.gatechenergyservices.com

Client: ENERGIJA RENEWABLES ROI LTD.

Job Title: SEVEN HILLS WIND FARM - SECTION 146B REQUEST

Drawing Title:

FIGURE 2.4: SITE LOCATION MAP 4 OF 11

Drawing No. SEV001S146B_PAS_LOC-0.06	Stage. PLANNING	
Scale: (A1) 1:2,500	Date: 11/12/2025	Revision No.: REV 04
Drawn By: EF	Checked By: JB	Confirmed By: SC

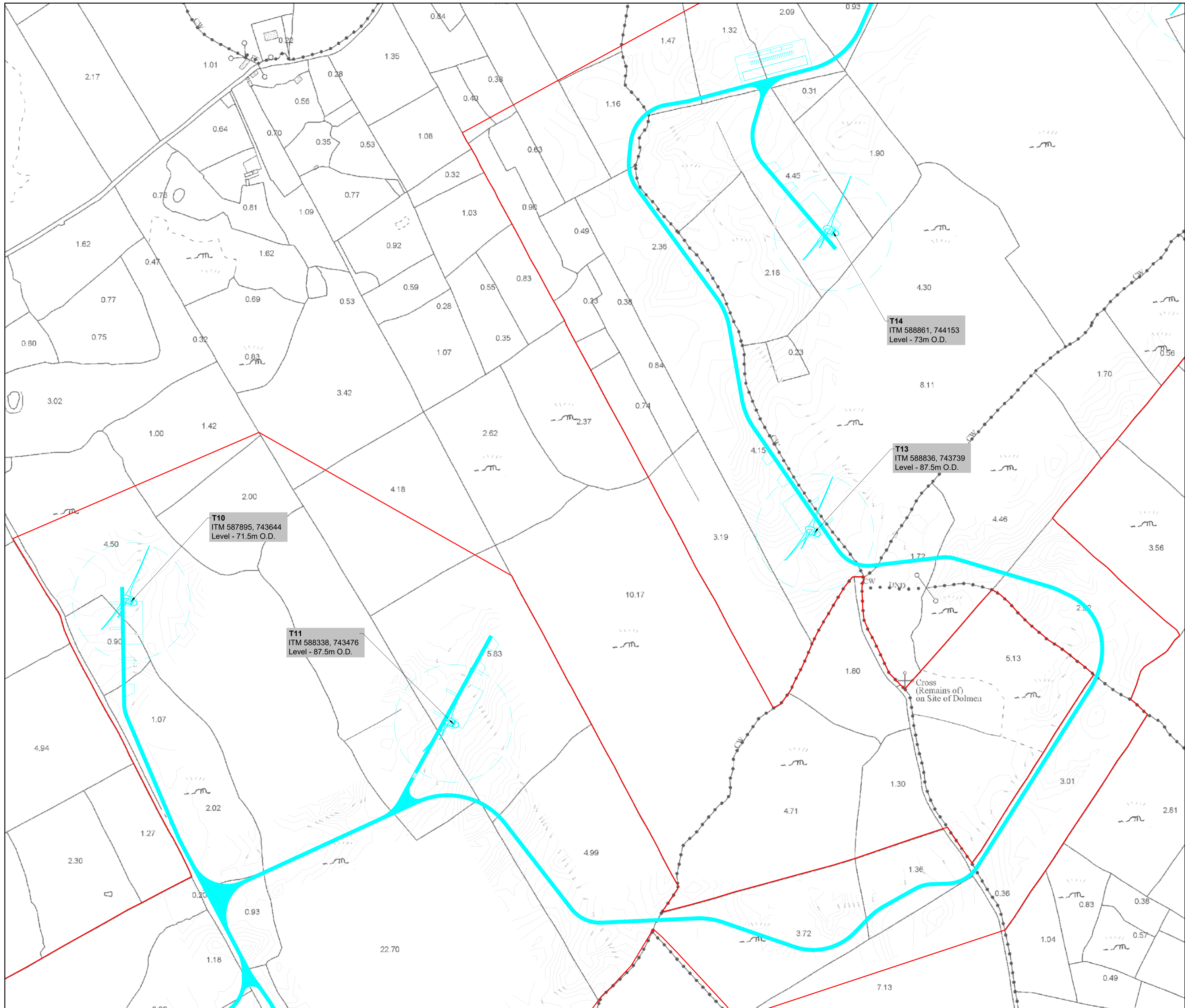

- LEGEND:**
- ▬▬▬ REVISED SITE BOUNDARY
 - ▬▬▬ FOLIO NOT INCLUDED IN THE SITE BOUNDARY
 - ▬▬▬ DEVELOPMENT PERMITTED UNDER AN BORD PLEANALA REFERENCE ABP-313750-22
 - ▬▬▬ PERMITTED 110KV UNDERGROUND CABLING TO BE OMITTED
 - ▬▬▬ PERMITTED SECTION OF WIND FARM CABLING TO BE REVISED
 - ▬▬▬ PROPOSED ACCESS TRACKS
 - ▬▬▬ PROPOSED REVISED ROUTE OF WIND FARM CABLING
 - ▬▬▬ PROPOSED WIND FARM CABLING
 - ▬▬▬ CONTOUR LINES

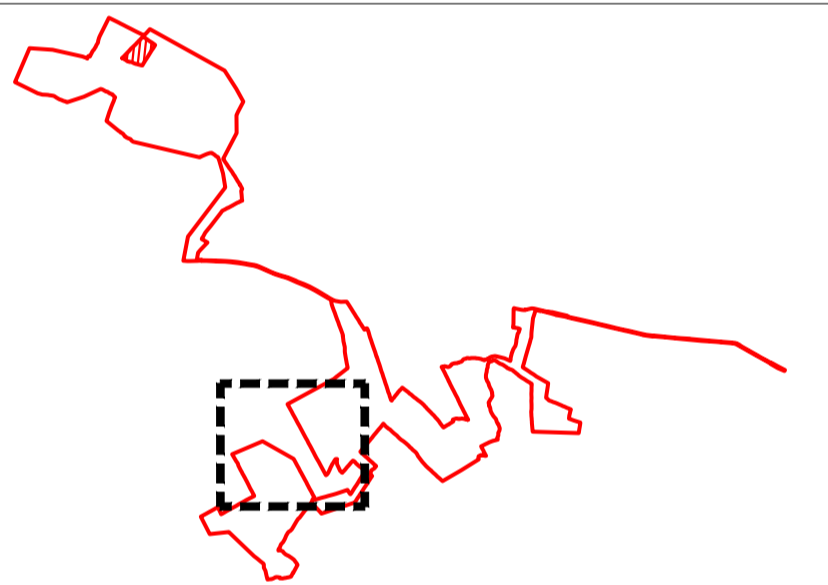
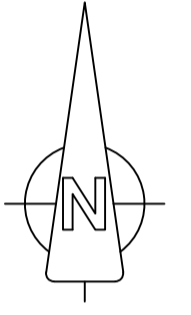

OSI © Licence: CYAL50441216 - OS Map Ref. No. - Prepared Using Irish Transverse Mercator (ITM).

Date:	Rev:	Description:	Drawn By:

Prepared By:



Galetech Energy Services
Clondargan, Stradone
Co. Cavan, H12 NV06
info@galetechenergyservices.com
www.galetechenergyservices.com

Client: **ENERGIA RENEWABLES ROI LTD.**

Job Title: **SEVEN HILLS WIND FARM - SECTION 146B REQUEST**

Drawing Title: **FIGURE 2.5: SITE LOCATION MAP 5 OF 11**

Drawing No. SEV001S146B_PAS_LOC-007 Stage: PLANNING

Scale: (A1) 1:2,500 Date: 11/12/2025 Revision No.: REV 04

Drawn By: EF Checked By: JB Confirmed By: SC

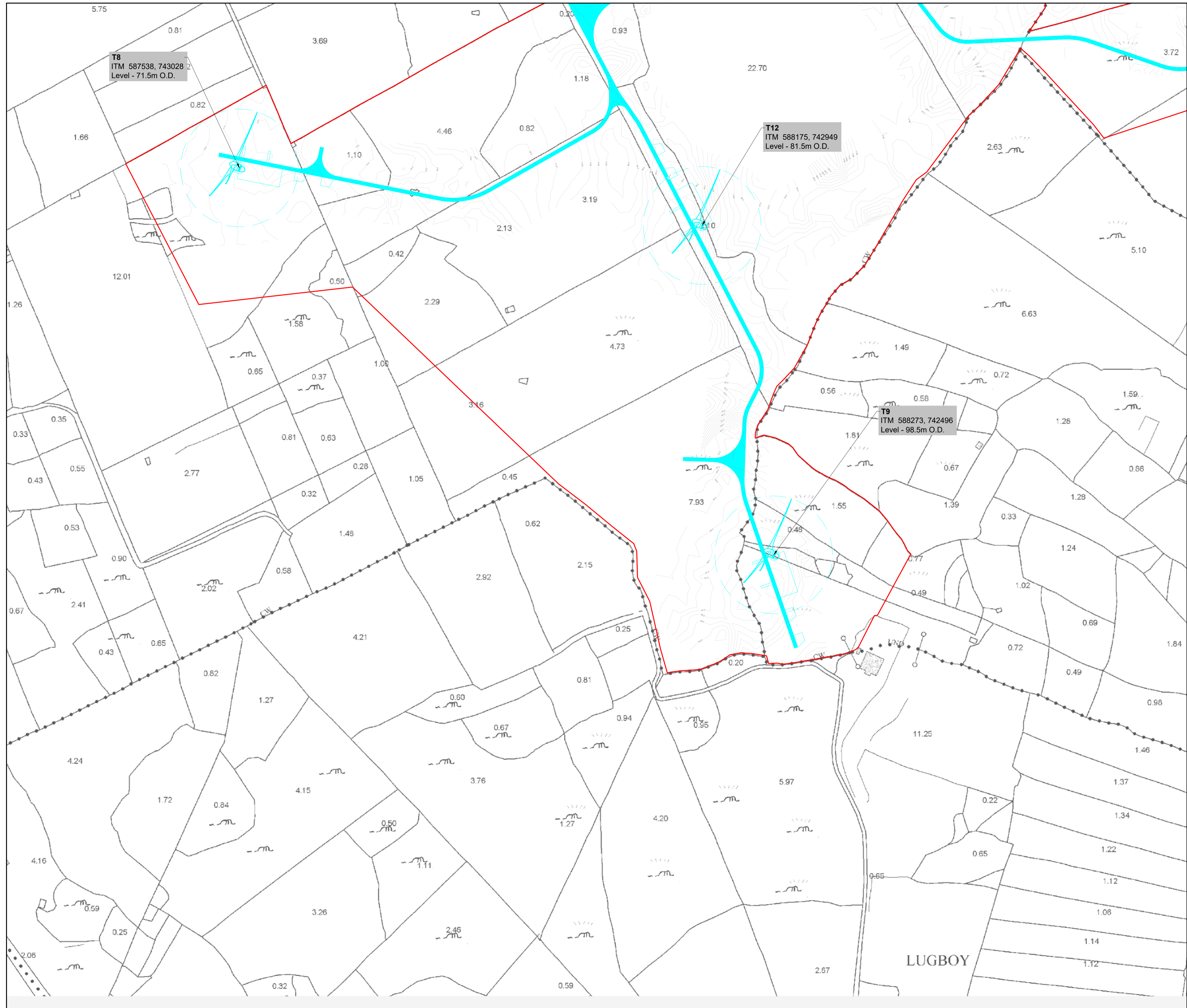

- LEGEND:**
- REVISED SITE BOUNDARY
 - ▨ FOLIO NOT INCLUDED IN THE SITE BOUNDARY
 - DEVELOPMENT PERMITTED UNDER AN BORD PLEANALA REFERENCE ABP-313/50-22
 - PERMITTED 110KV UNDERGROUND CABLING TO BE OMITTED
 - PERMITTED SECTION OF WIND FARM CABLING TO BE REVISED
 - PROPOSED ACCESS TRACKS
 - - - PROPOSED REVISED ROUTE OF WIND FARM CABLING
 - PROPOSED WIND FARM CABLING
 - CONTOUR LINES

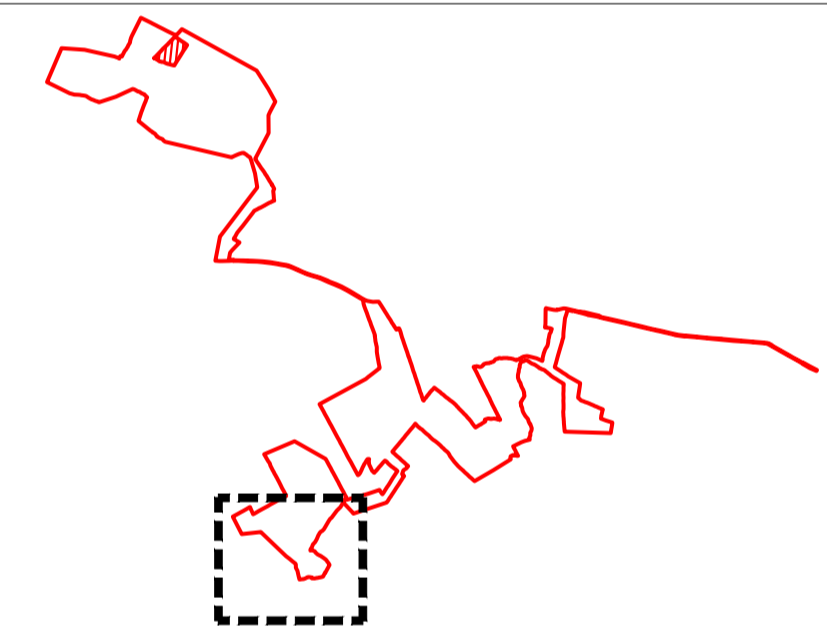
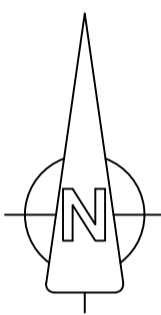

OSI © Licence: CYAL50441216 - OS Map Ref. No. - Prepared Using Irish Transverse Mercator (ITM).

Date:	Rev:	Description:	Drawn By:

Prepared By:



Galetech Energy Services
Clondargan, Stradone
Co. Cavan, H12 NV06
info@galetechenergyservices.com
www.galetechenergyservices.com

Client: ENERZIA RENEWABLES ROI LTD.

Job Title: SEVEN HILLS WIND FARM - SECTION 146B REQUEST

Drawing Title: FIGURE 2.6: SITE LOCATION MAP 6 OF 11

Drawing No. SEV001S146B_PAS_LOC-008	Stage. PLANNING
---	---------------------------

Scale: (A1) 1:2,500	Date: 11/12/2025	Revision No.: REV 04
-------------------------------	----------------------------	--------------------------------

Drawn By: EF	Checked By: JB	Confirmed By: SC
------------------------	--------------------------	----------------------------

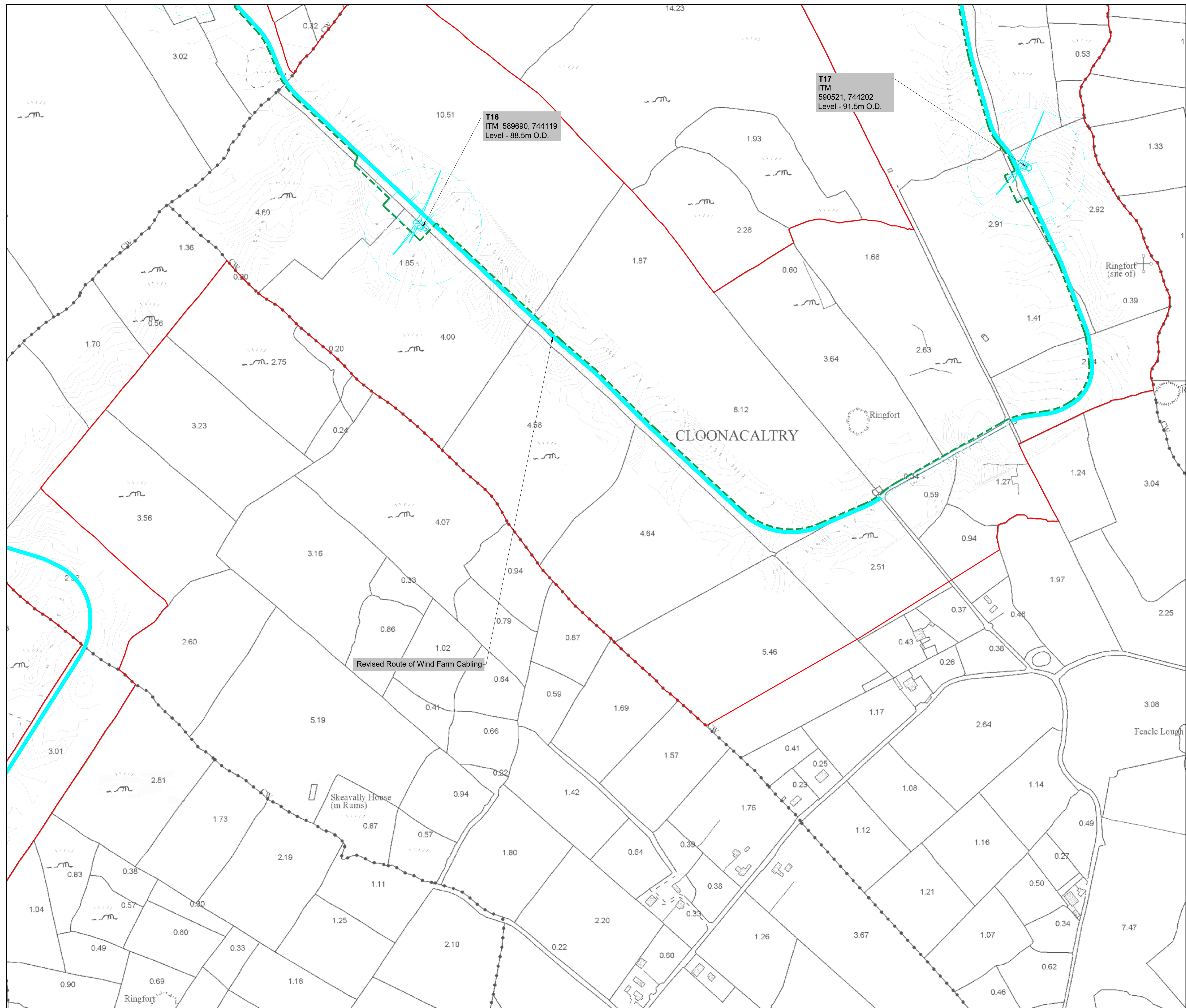

- LEGEND:**
- ▬▬▬▬ REVISED SITE BOUNDARY
 - ▬▬▬▬ FOLIO NOT INCLUDED IN THE SITE BOUNDARY
 - ▬▬▬▬ DEVELOPMENT PERMITTED UNDER AN BORD PLEANALA REFERENCE ABP-313/50-22
 - ▬▬▬▬ PERMITTED 110KV UNDERGROUND CABLING TO BE OMITTED
 - ▬▬▬▬ PERMITTED SECTION OF WIND FARM CABLING TO BE REVISED
 - ▬▬▬▬ PROPOSED ACCESS TRACKS
 - - - - - PROPOSED REVISED ROUTE OF WIND FARM CABLING
 - - - - - PROPOSED WIND FARM CABLING
 - ▬▬▬▬ CONTOUR LINES

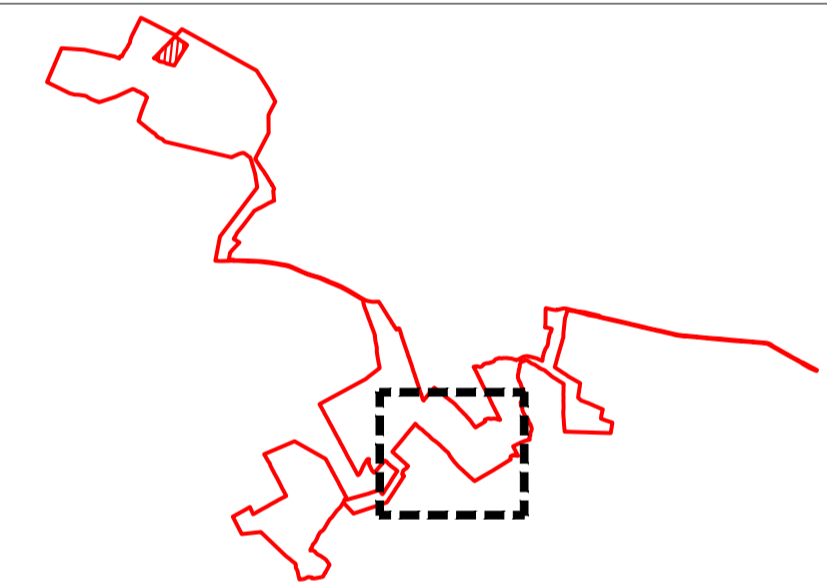
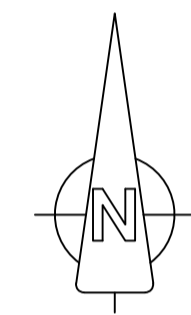

OSI © Licence: CYAL50441216 - OS Map Ref. No. - Prepared Using Irish Transverse Mercator (ITM).

Date:	Rev:	Description:	Drawn By:

Prepared By:

Galetech Energy Services
Clondargan, Stradone
Co. Cavan, H12 NV06
info@galetechenergyservices.com
www.galetechenergyservices.com

Client: ENERGINIA RENEWABLES ROI LTD.

Job Title: SEVEN HILLS WIND FARM - SECTION 146B REQUEST

Drawing Title: FIGURE 2.7: SITE LOCATION MAP 7 OF 11

Drawing No.: SEV001S146B_PAS_LOC-0.09 **Stage:** PLANNING

Scale: (A1) 1:2,500 **Date:** 11/12/2025 **Revision No.:** REV 04

Drawn By: EF **Checked By:** JB **Confirmed By:** SC

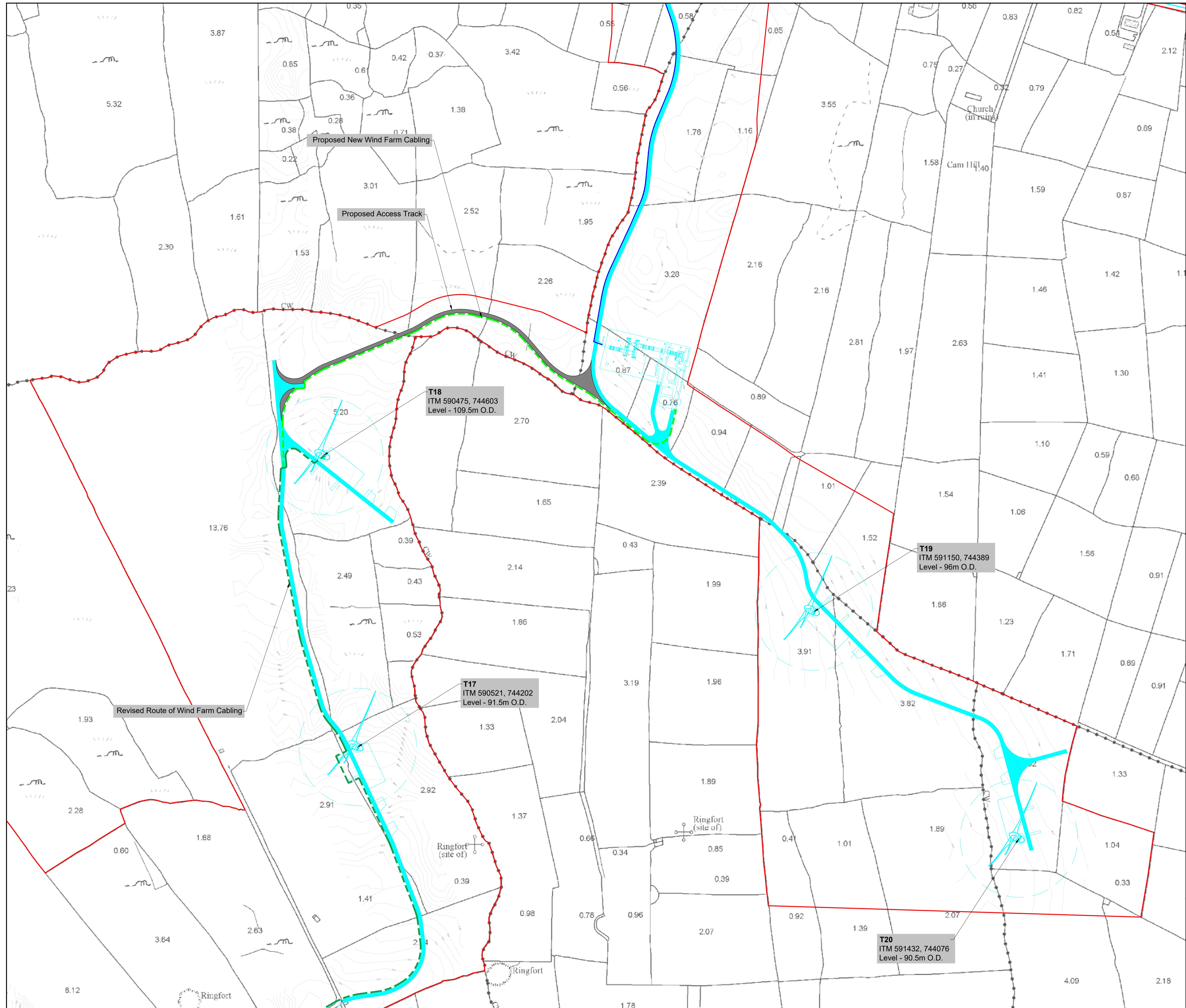

- LEGEND:**
- REVISED SITE BOUNDARY
 - FOLIO NOT INCLUDED IN THE SITE BOUNDARY
 - DEVELOPMENT PERMITTED UNDER AN BORD PLEANALA REFERENCE ABP-313750-22
 - PERMITTED 110KV UNDERGROUND CABLING TO BE OMITTED
 - PERMITTED SECTION OF WIND FARM CABLING TO BE REVISED
 - PROPOSED ACCESS TRACKS
 - PROPOSED REVISED ROUTE OF WIND FARM CABLING
 - PROPOSED WIND FARM CABLING
 - CONTOUR LINES

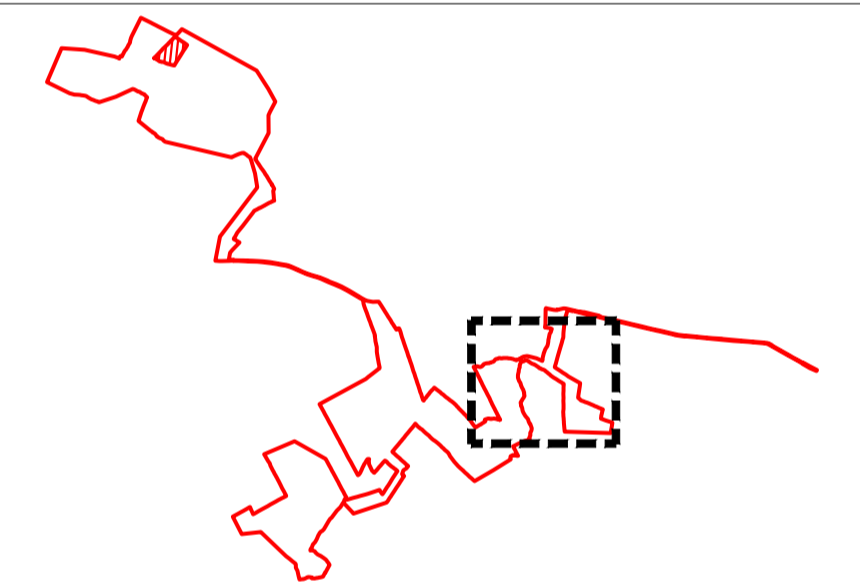
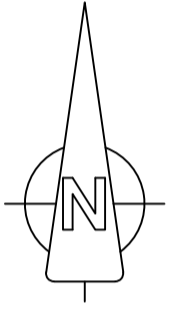

OSI © Licence: CYAL50441216 - OS Map Ref. No. - Prepared Using Irish Transverse Mercator (ITM).

Date:	Rev:	Description:	Drawn By:

Prepared By:



Galetech Energy Services
Clondargan, Stradone
Co. Cavan, H12 NV06
info@galetechenergyservices.com
www.galetechenergyservices.com

Client: **ENERGIA RENEWABLES ROI LTD.**

Job Title: **SEVEN HILLS WIND FARM - SECTION 146B REQUEST**

Drawing Title: **FIGURE 2.8: SITE LOCATION MAP 8 OF 11**

Drawing No. SEV001S146B_PAS_LOC-0.10	Stage. PLANNING
---	--------------------

Scale: (A1) 1:2,500	Date: 11/12/2025	Revision No.: REV 04
------------------------	---------------------	-------------------------

Drawn By: EF	Checked By: JB	Confirmed By: SC
-----------------	-------------------	---------------------

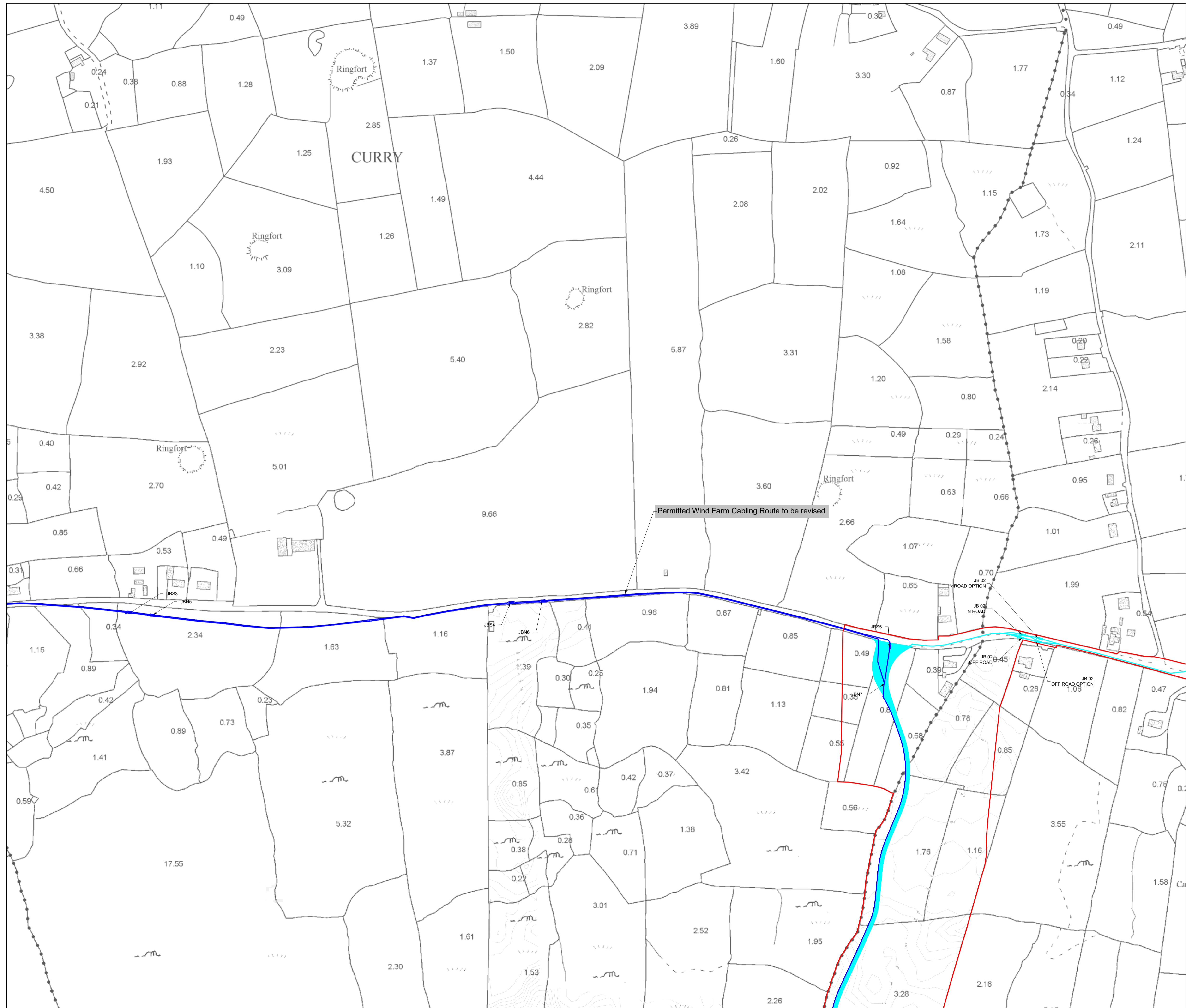

- LEGEND:**
- REVISED SITE BOUNDARY
 - FOLIO NOT INCLUDED IN THE SITE BOUNDARY
 - DEVELOPMENT PERMITTED UNDER AN BORD PLEANALA REFERENCE ABP-313/50-22
 - PERMITTED 110KV UNDERGROUND CABLING TO BE OMITTED
 - PERMITTED SECTION OF WIND FARM CABLING TO BE REVISED
 - PROPOSED ACCESS TRACKS
 - PROPOSED REVISED ROUTE OF WIND FARM CABLING
 - PROPOSED WIND FARM CABLING
 - CONTOUR LINES

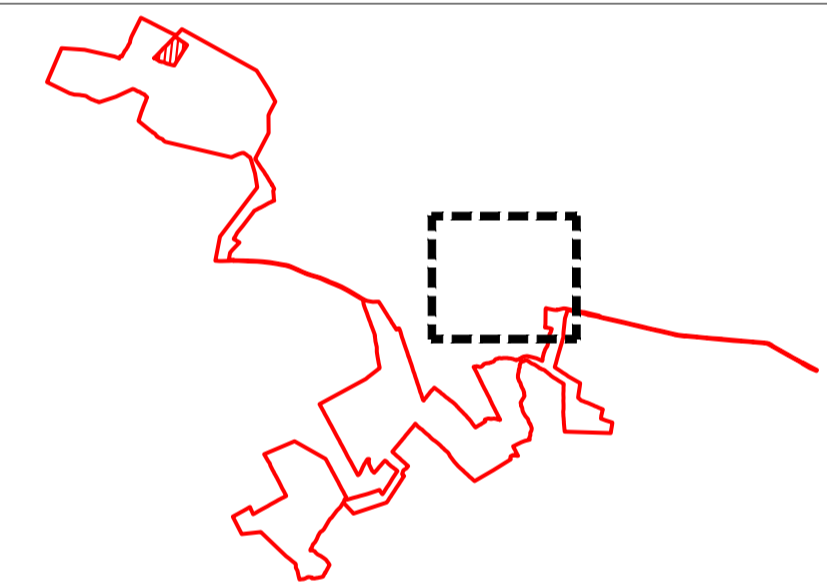
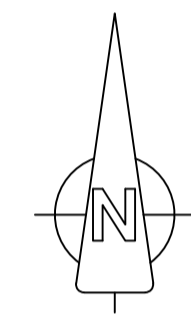

Permitted Wind Farm Cabling Route to be revised

OSI © Licence: CYAL50441216 - OS Map Ref. No. - Prepared Using Irish Transverse Mercator (ITM).

Date:	Rev:	Description:	Drawn By:
Prepared By:			

Gaitech Energy Services
 Clondargan, Stradone
 Co. Cavan, H12 NV06
 info@gatechenergyservices.com
 www.gatechenergyservices.com

Client:	ENERGIA RENEWABLES ROI LTD.
Job Title:	SEVEN HILLS WIND FARM - SECTION 146B REQUEST
Drawing Title:	FIGURE 2.9: SITE LOCATION MAP 9 OF 11

Drawing No. SEV001S146B_PAS_LOC-0.11	Stage. PLANNING
Scale: (A1) 1:2,500	Date: 11/12/2025
Revision No.: REV 04	Checked By: JB
Drawn By: EF	Confirmed By: SC

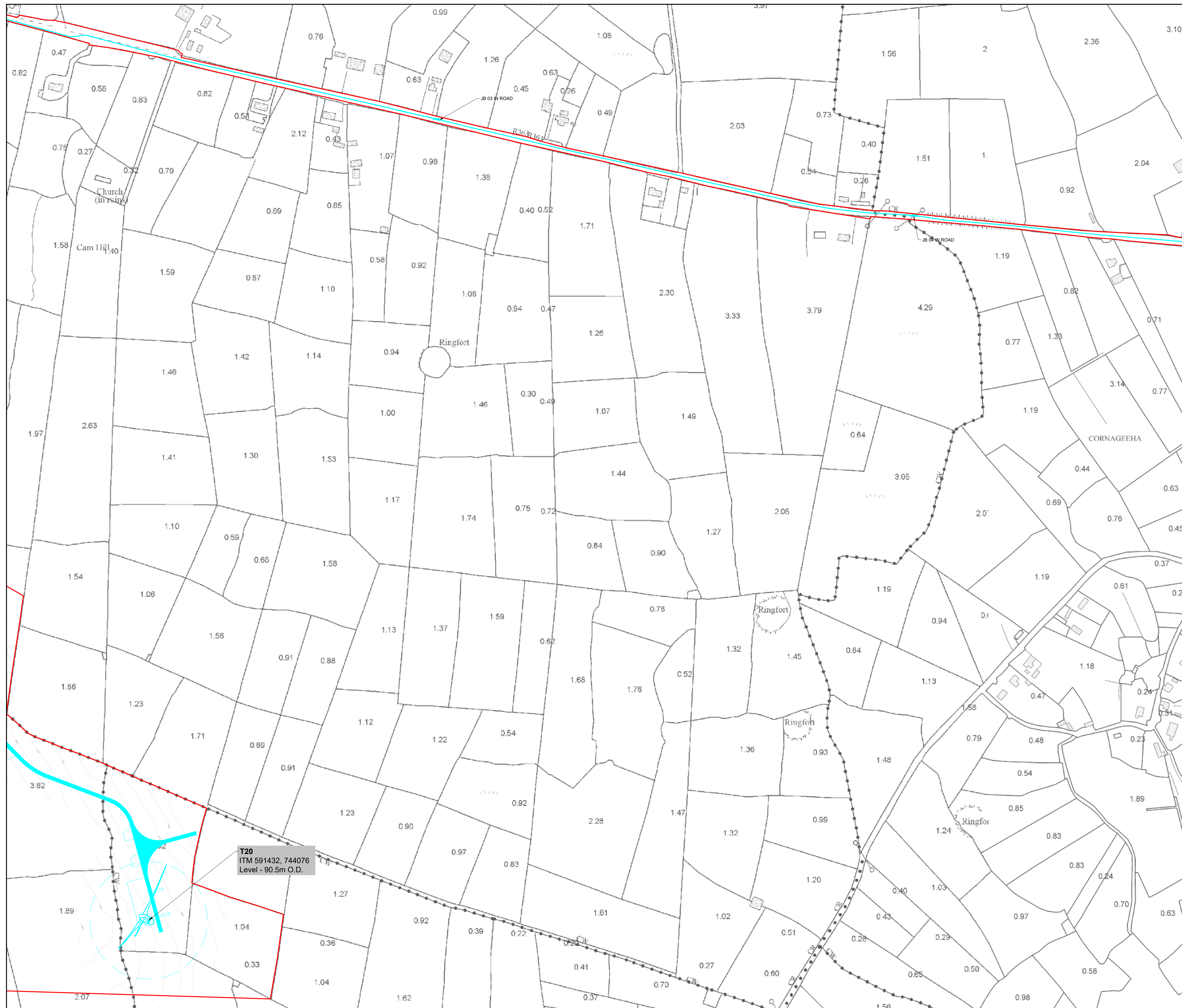

- LEGEND:**
- REVISED SITE BOUNDARY
 - FOLIO NOT INCLUDED IN THE SITE BOUNDARY
 - DEVELOPMENT PERMITTED UNDER AN BORD PLEANÁLA REFERENCE ABP-313750-22
 - PERMITTED 110KV UNDERGROUND CABLING TO BE OMITTED
 - PERMITTED SECTION OF WIND FARM CABLING TO BE REVISED
 - PROPOSED ACCESS TRACKS
 - PROPOSED REVISED ROUTE OF WIND FARM CABLING
 - PROPOSED WIND FARM CABLING
 - CONTOUR LINES

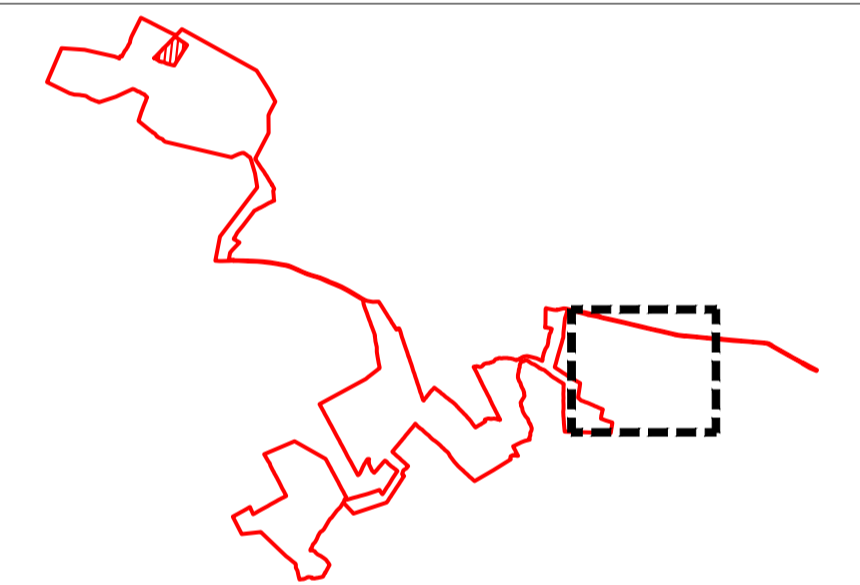
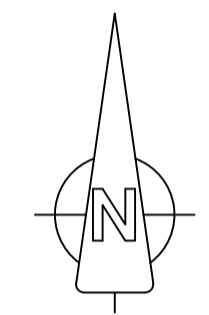

OSI © Licence: CYAL50441216 - OS Map Ref. No. - Prepared Using Irish Transverse Mercator (ITM).

Date:	Rev:	Description:	Drawn By:

Prepared By:



Galetech Energy Services
Clondargan, Stradone
Co. Cavan, H12 NV06
info@galetechenergyservices.com
www.galetechenergyservices.com

Client: ENERGIJA RENEWABLES ROI LTD.

Job Title: SEVEN HILLS WIND FARM - SECTION 146B REQUEST

Drawing Title: FIGURE 2.10: SITE LOCATION MAP 10 OF 11

Drawing No.	Stage.
SEV001S146B_PAS_LOC-0.12	PLANNING

Scale:	Date:	Revision No.:
(A1) 1:2,500	11/12/2025	REV 04

Drawn By:	Checked By:	Confirmed By:
EF	JB	SC

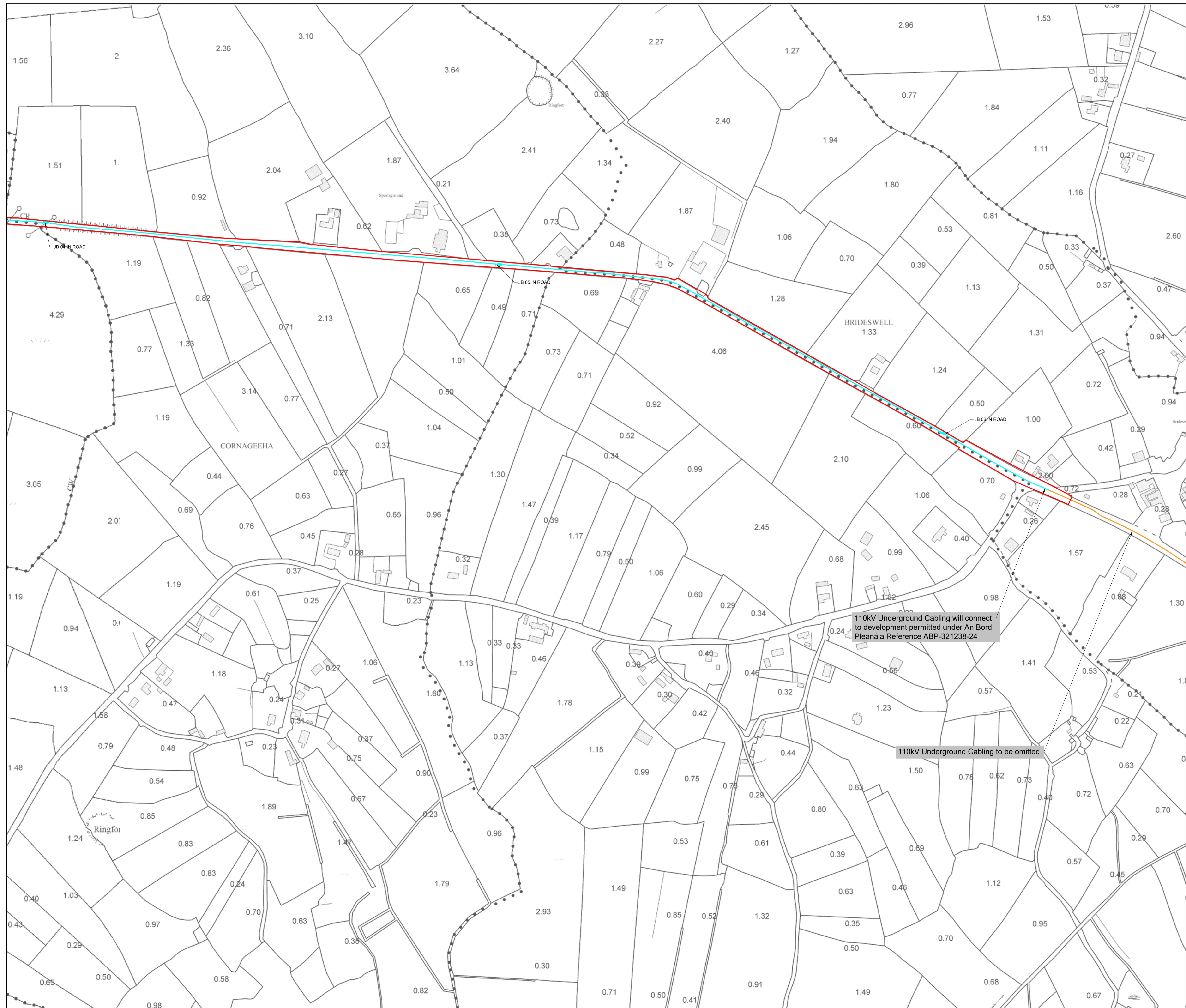

- LEGEND:**
- REVISED SITE BOUNDARY
 - FOLIO NOT INCLUDED IN THE SITE BOUNDARY
 - DEVELOPMENT PERMITTED UNDER AN BORD PLEANÁLA REFERENCE ABP-313750-22
 - PERMITTED 110kV UNDERGROUND CABLING TO BE OMITTED
 - PERMITTED SECTION OF WIND FARM CABLING TO BE REVISED
 - PROPOSED ACCESS TRACKS
 - PROPOSED REVISED ROUTE OF WIND FARM CABLING
 - PROPOSED WIND FARM CABLING
 - CONTOUR LINES

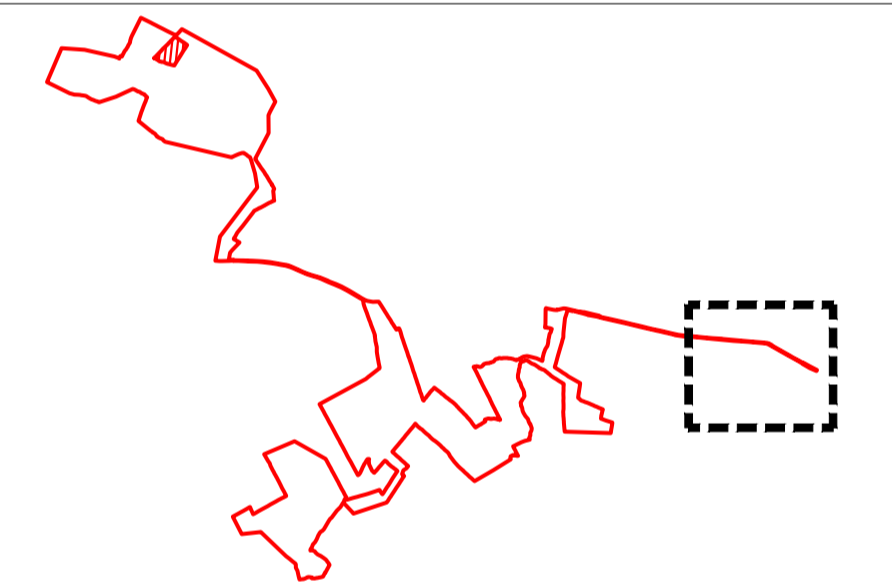
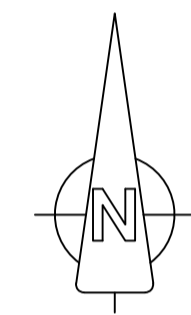

OSI © Licence: CYAL50441216 - OS Map Ref. No. - Prepared Using Irish Transverse Mercator (ITM).

Date:	Rev:	Description:	Drawn By:

Prepared By:

Galetech Energy Services
Clondargan, Stradone
Co. Cavan, H12 NV06
info@galetechenergyservices.com
www.galetechenergyservices.com

Client:	ENERGIA RENEWABLES ROI LTD.
Job Title:	SEVEN HILLS WIND FARM - SECTION 146B REQUEST
Drawing Title:	FIGURE 2.11: SITE LOCATION MAP 11 OF 11
Drawing No.:	SEV001S146B_PAS_LOC-0.13
Stage:	PLANNING

Scale: (A1) 1:2,500	Date: 11/12/2025	Revision No.: REV 04
Drawn By: EF	Checked By: JB	Confirmed By: SC

Typical Service Trench Crossing Track Scale 1:20

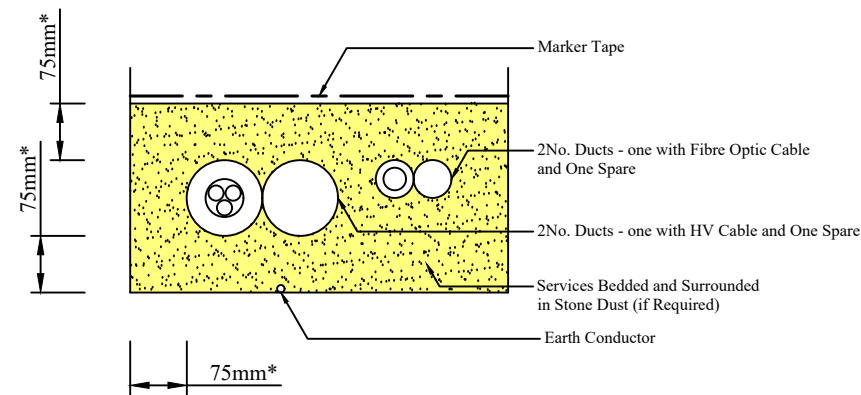

Enlarged Services Detail
Scale 1:10

Typical Service Trench Detail Scale 1:20

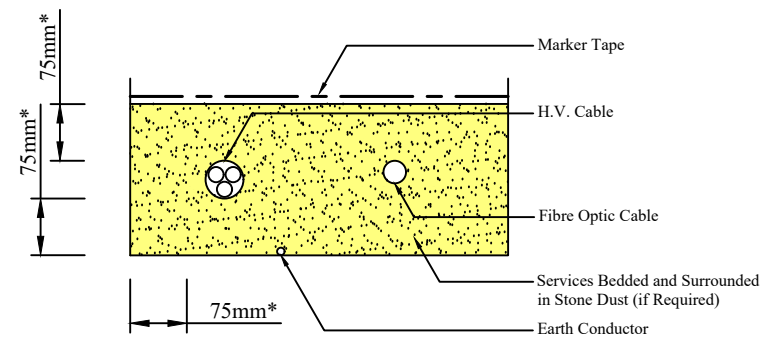

Enlarged Services Detail
Scale 1:10

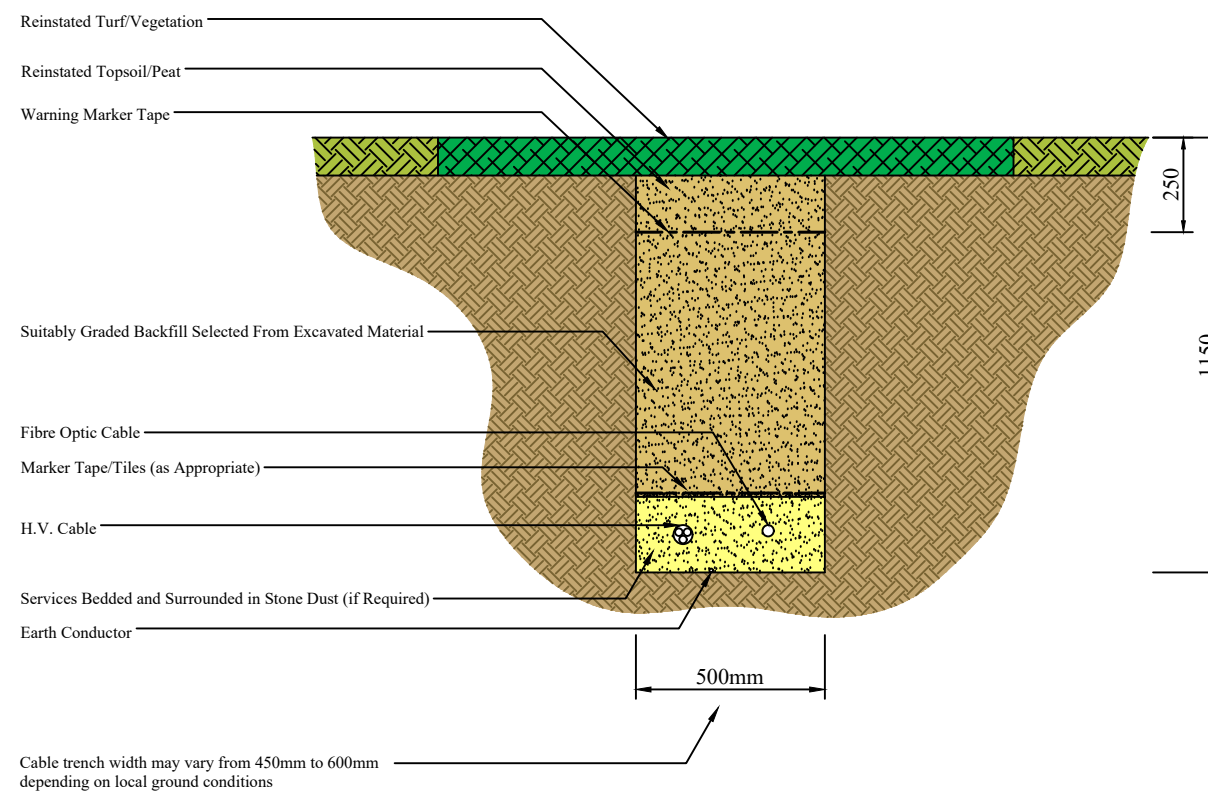
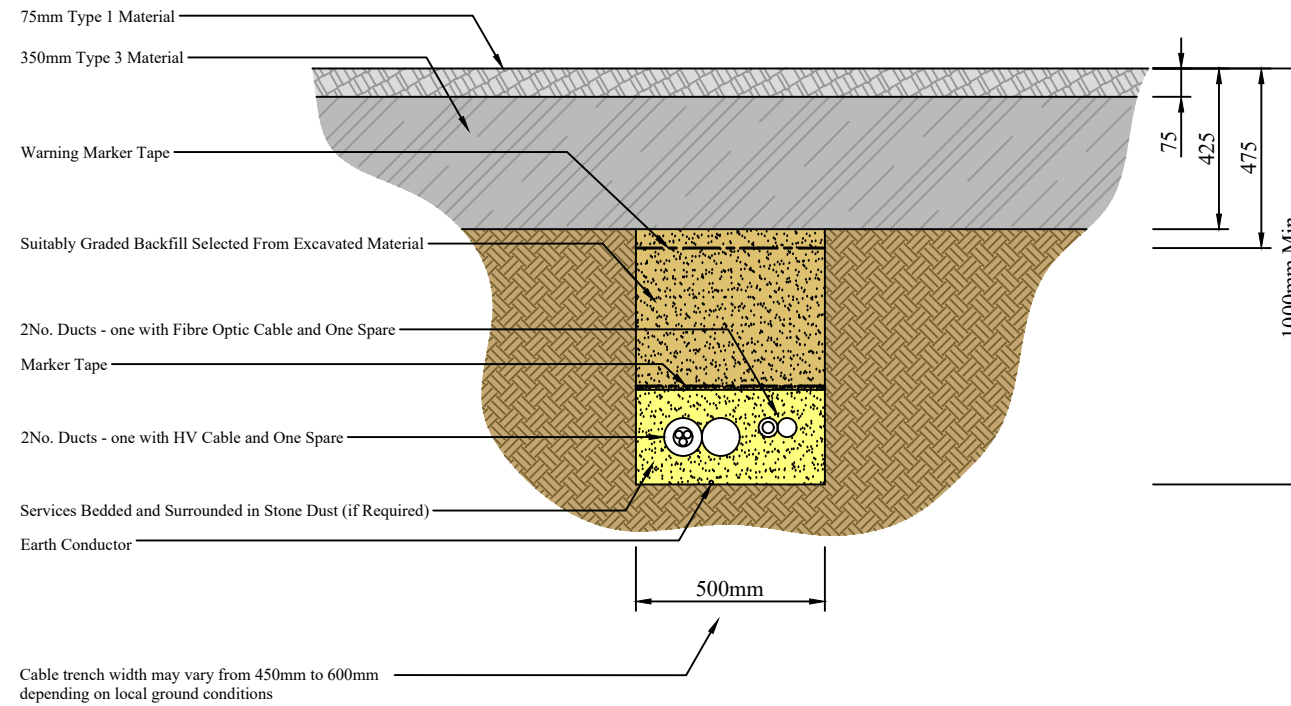

Prepared by:



Note:

- 1) Depth of cable trenches to suit sub-surface conditions. i.e. to be located in stable soil conditions.
- 2) Dimensions with * against them refer to specific clearances around the H.V. cable.

Date:	Rev.:	Description:	Drawn By:

Agent Address:

Galetech Energy Services,
Clondargan,
Stradone,
Co. Cavan

Job Title:

Seven Hills Wind Farm

Client:

Energia Renewables ROI Limited

Drawing Title:

Figure 3: Typical Arrangement of
Wind Farm Cabling

Drawing No.:
SEV001S146B_PAS_GA-0.01

Revision No.:
0

Scale:
(A3) 1:10

Date:
11/12/2025

Drawn By:
EF.

Checked By:
JB

Confirmed By:
S.C.

NOTES:

- 1) ALL DIMENSIONS MUST BE CHECKED ON SITE AND NOT Scaled FROM THIS DRAWING.
- 2) ALL DIMENSIONS IN MILLIMETRES UNLESS OTHERWISE STATED.
- 3) PLEASE NOTE THAT THE ELEVATIONS/DIMENSIONS ILLUSTRATED ON THE DRAWING ARE INDICATIVE ONLY. THE PRECISE SPECIFICATION AND DETAIL OF THE MODULE WILL BE DETERMINED BY THE ELECTRICAL EQUIPMENT SUPPLIER FOLLOWING A COMPETITIVE TENDER.

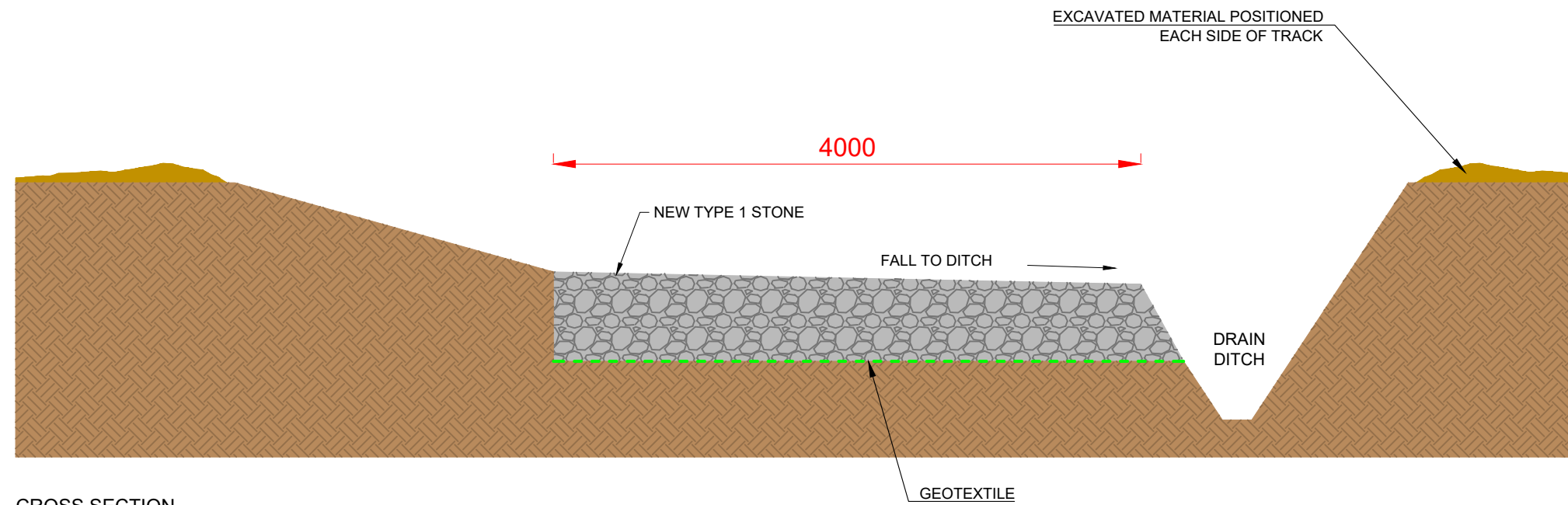

CROSS SECTION
(Scale 1:40)

Date:	Rev:	Description:	Drawn By:
-------	------	--------------	-----------

Prepared By:



Galetech Energy Services
 Clondargan, Stradone
 Co. Cavan, H12 NV06
 info@galetechenergyservices.com
 www.galetechenergyservices.com

Client:
ENERGIA RENEWABLES ROI LIMITED

Job Title:
SEVEN HILLS WIND FARM

Drawing Title:

FIGURE 4: ACCESS TRACK SPECIFICATION

Drawing No.: SEV001S146B_PAS_GA-0.02		Stage: PLANNING
Scale: (A3) 1:40	Date: 11/12/2025	Revision No.: REV 00
Drawn By: EF	Checked By: JB	Confirmed By: SC